

Les Systèmes d'Exploitation

ICN 1ère



Les Systèmes d'Exploitation

ICN 1ère

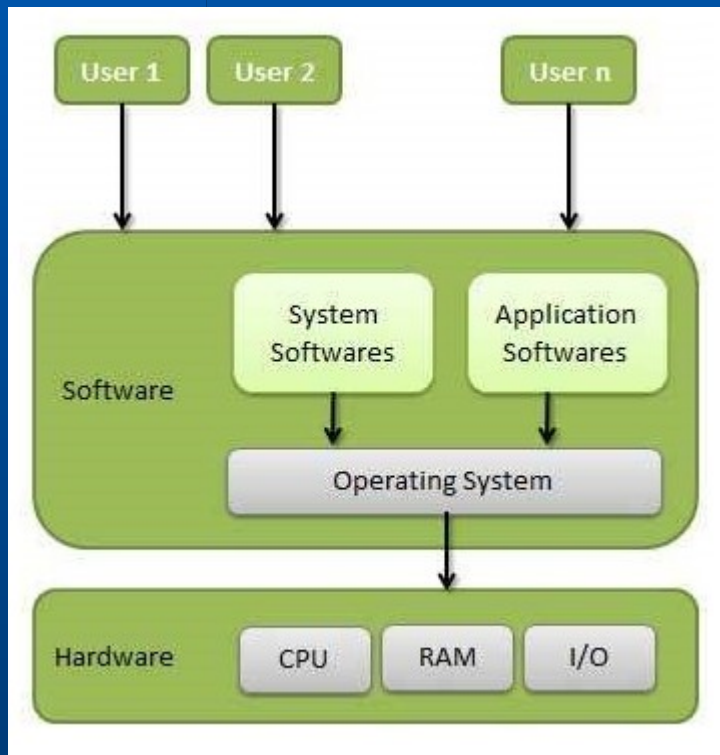

Interface

- Bas niveau : matériel
processus
mémoire
pilotes E/S
- Haut niveau : fichiers
gestion de fichiers

Les Systèmes d'Exploitation

ICN 1ère



Systeme d'exploitation (**Operating System**)
et noyau (**kernel**)

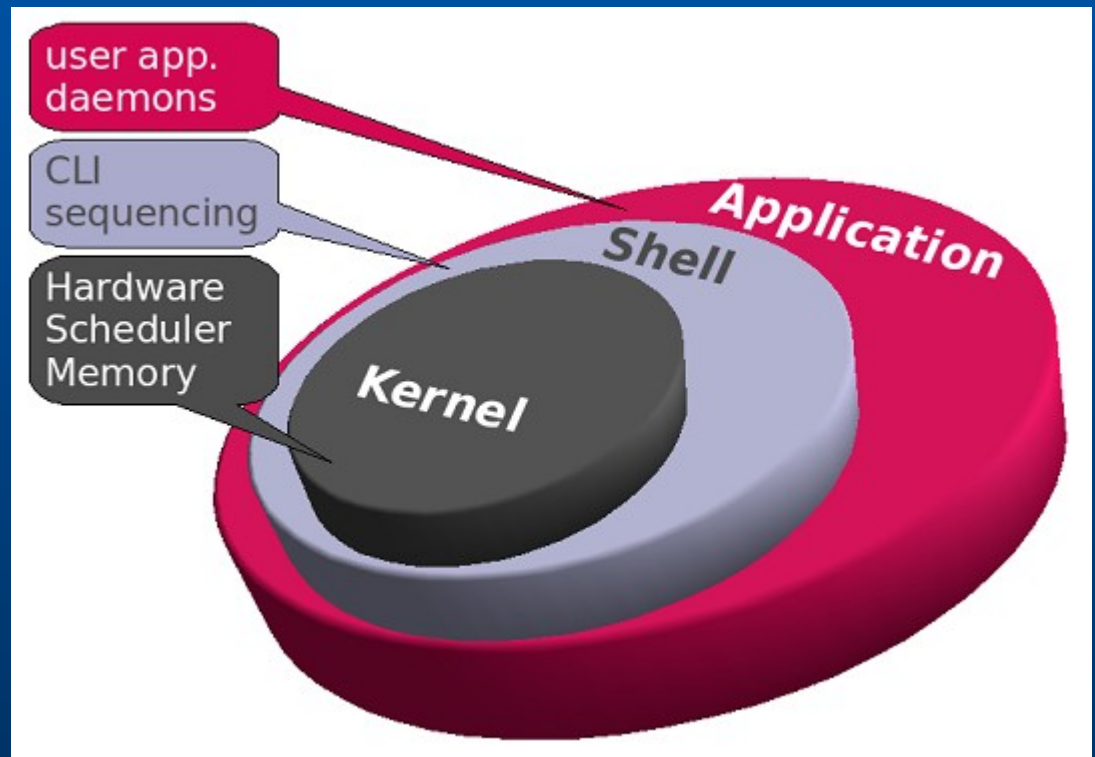

Les Systèmes d'Exploitation

ICN 1ère



- Mémoire virtuelle
- Mémoire physique
- Mémoire d'échange (swap)

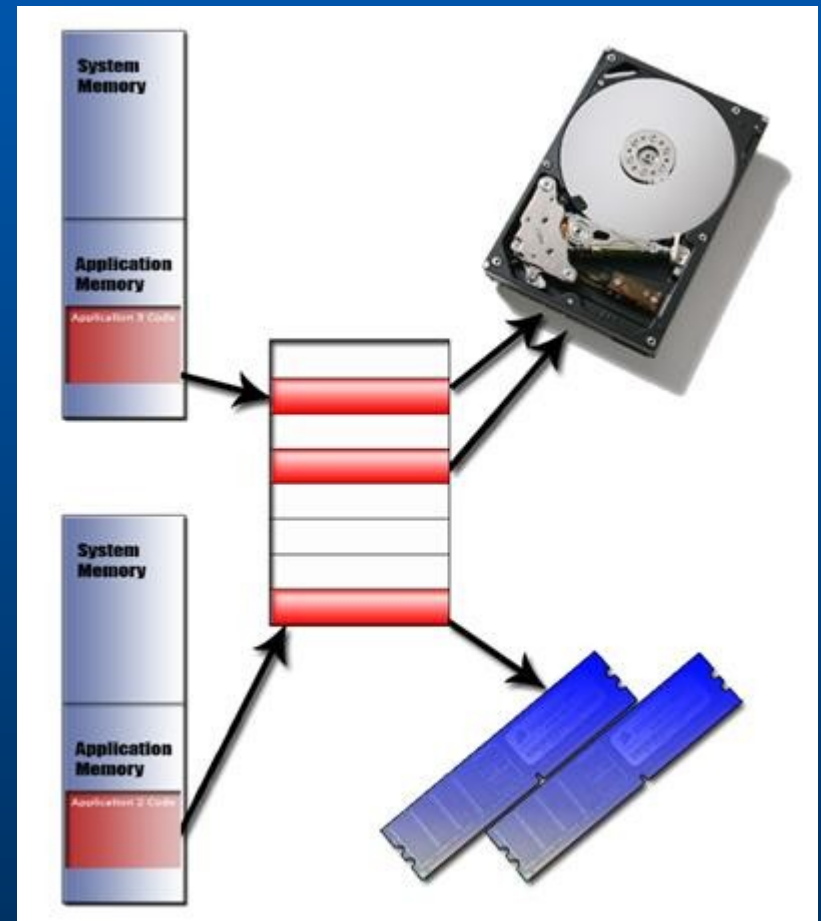

Les Systèmes d'Exploitation

ICN 1ère



- Ordonnanceur (**scheduler**)
- Algorithme du tourniquet (**round robin**)

OS **préemptif**
OS **coopératif**

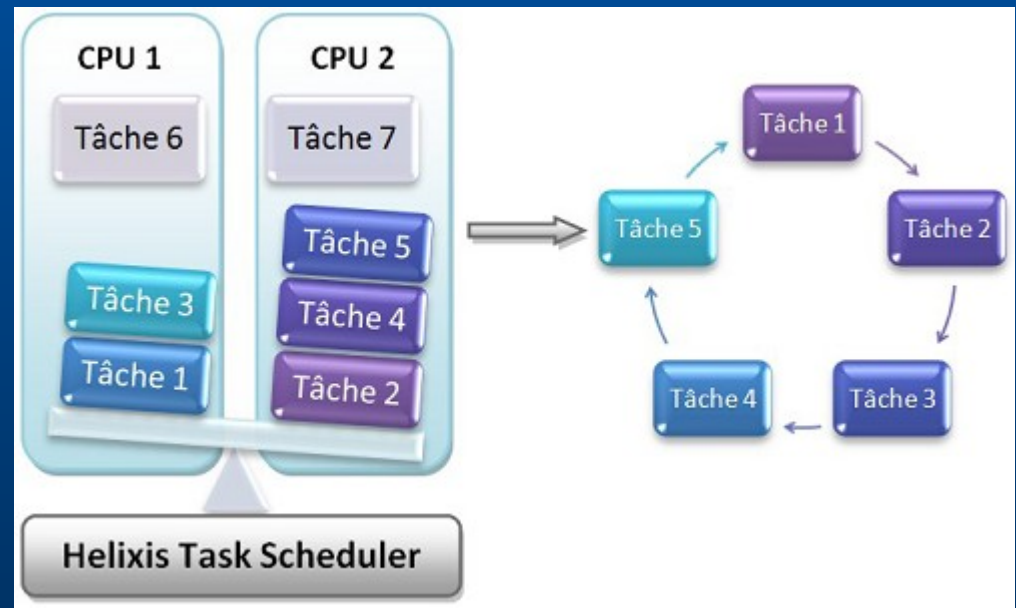

Les Systèmes d'Exploitation

ICN 1ère



Couche d'abstraction du matériel (**hardware**)
Appels systèmes (**system calls**)

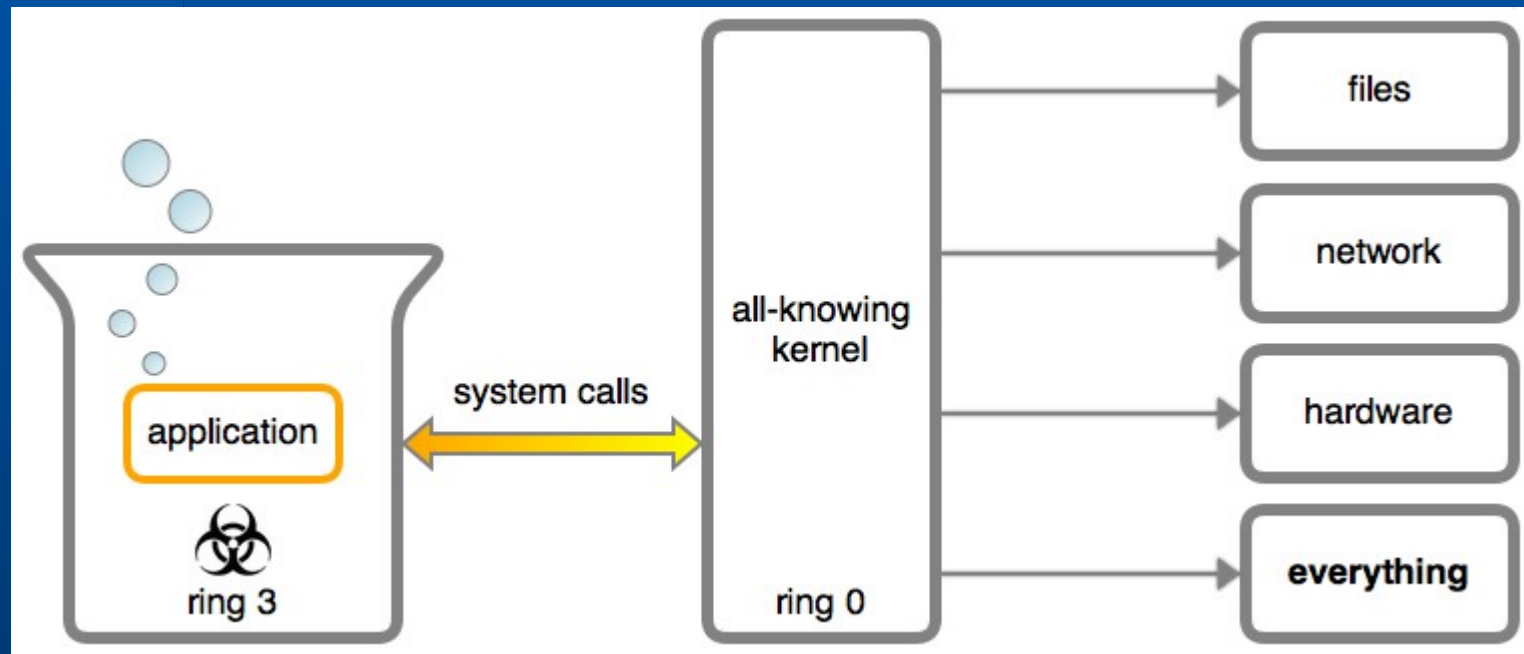

Les Systèmes d'Exploitation

ICN 1ère



Se répartir / groupe un des OS suivants :



GNU/linux



Mac OS



FreeBSD



MS-Windows

1. Donner les évolutions successives des versions
2. Présenter leurs avantages/inconvénients (technique, économique, sociale, ...)



Les Systèmes d'Exploitation

ICN 1ère

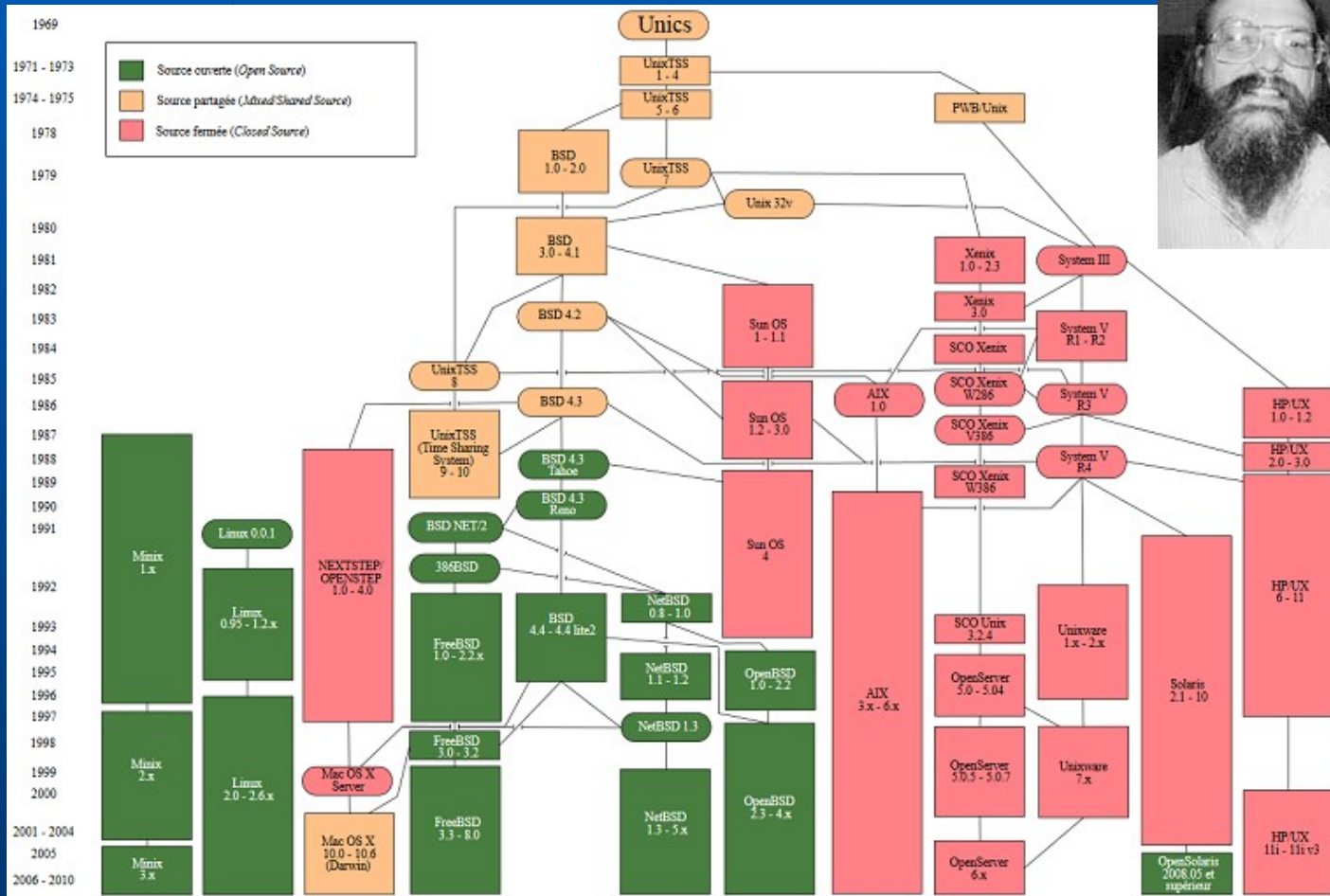

Les Systèmes d'Exploitation

ICN 1ère

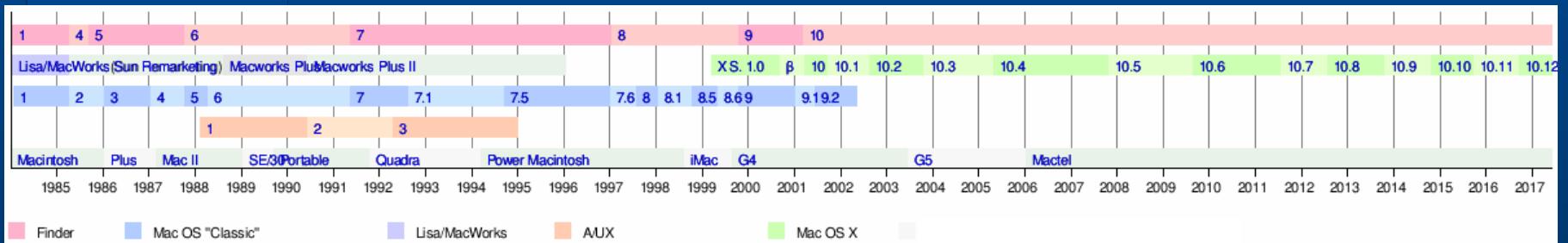

Les Systèmes d'Exploitation

ICN 1ère

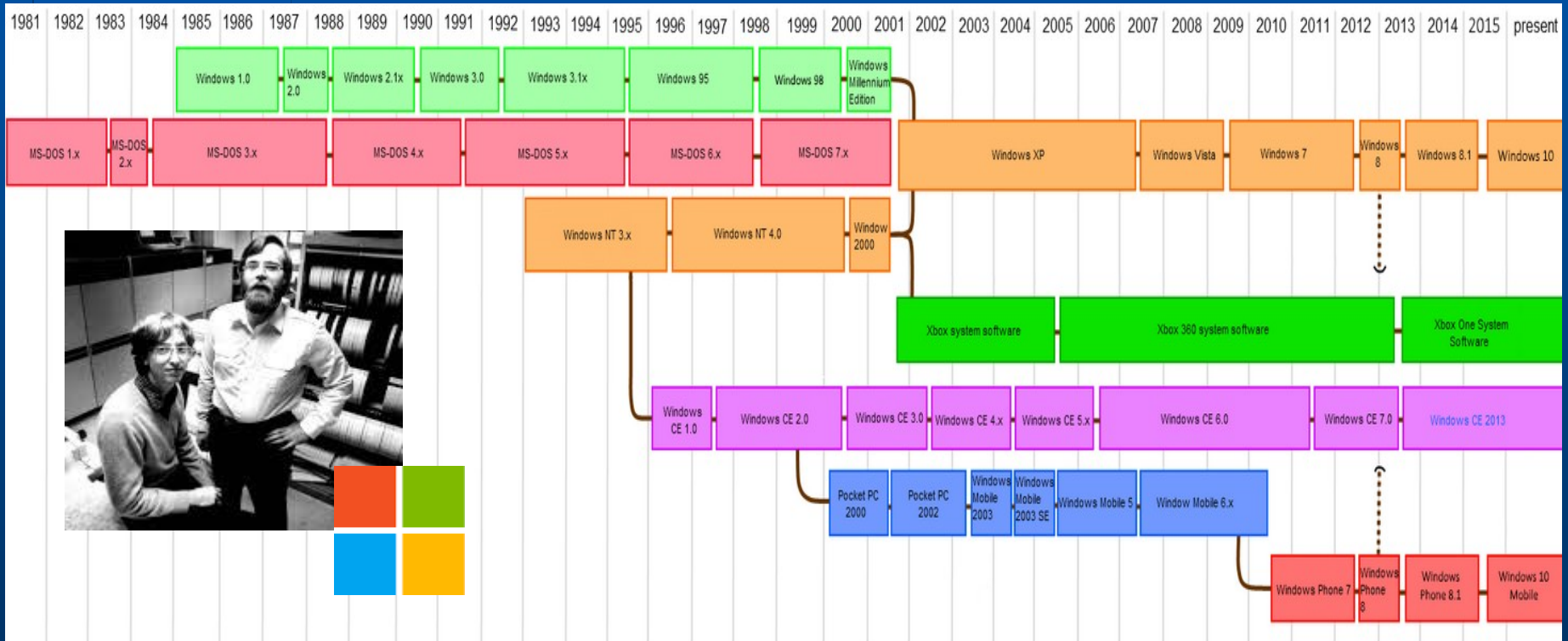

Les Systèmes d'Exploitation

ICN 1ère

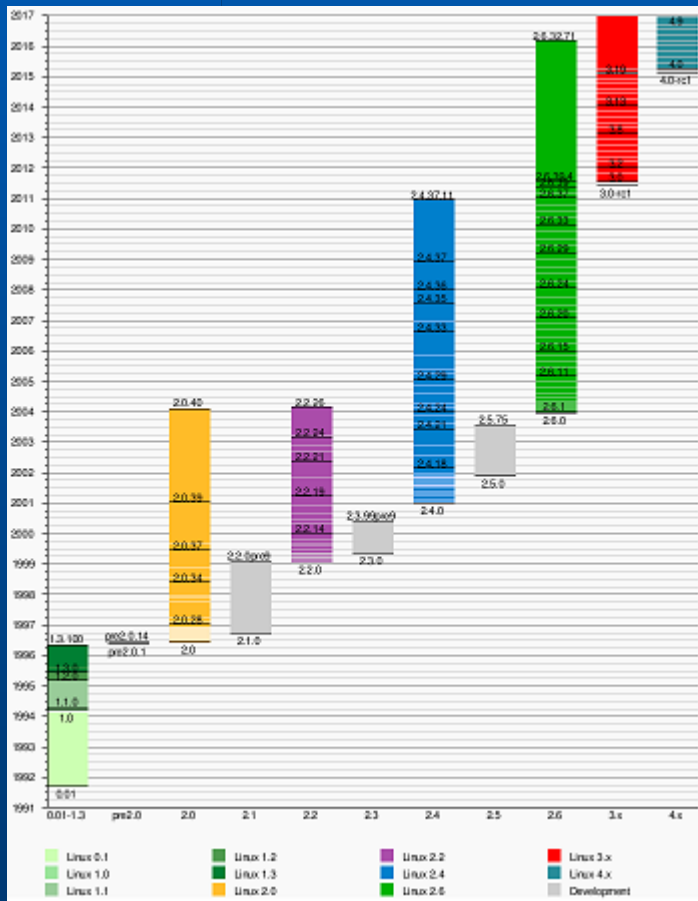

Les Systèmes d'Exploitation

ICN 1ère



Parts de marché

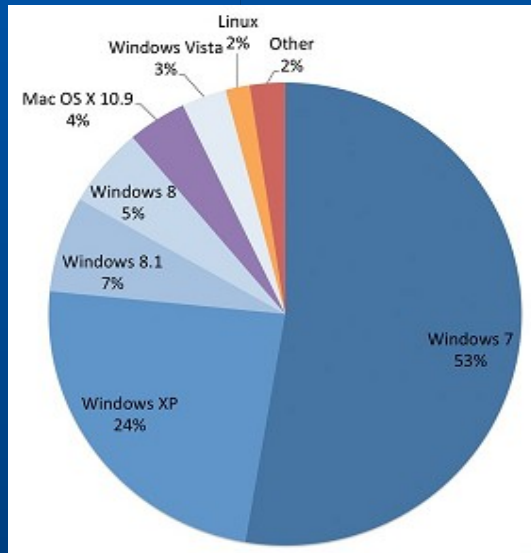

PC

(desktop & laptop)

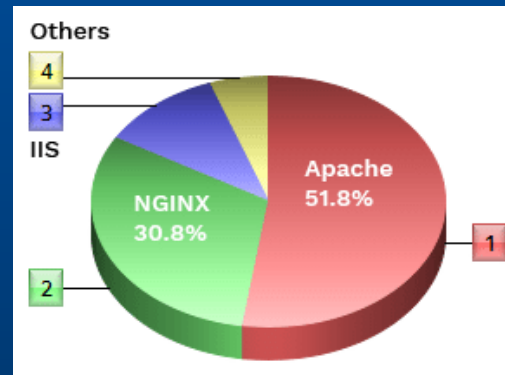

Serveur

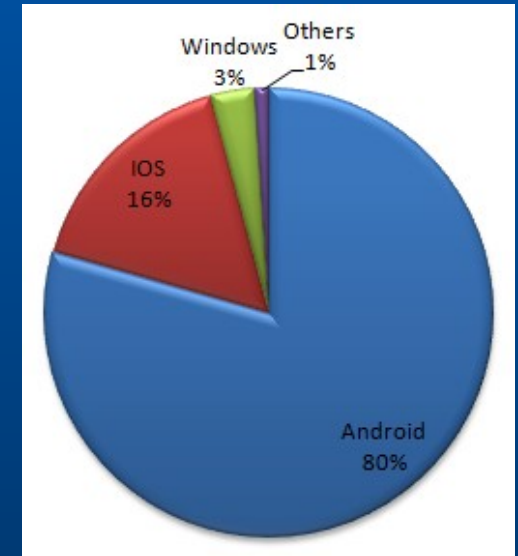

Smartphone
Tablette